

MORI SEIKI

BMT-60 Models





Mori Seiki: NL
1500/2000/2500/3000
NLX 1500/2000/2500/3000
NT 3250/4200/4250/4300/5400
NZL 2500

MADAULA





creative solutions

DMG: CTX Beta 800
Goodway: GS-2600Y
Chevalier: FNL-250/300
Feeler: HT-30 MC S/SY
MT Rent: MTcurt T25Y SY

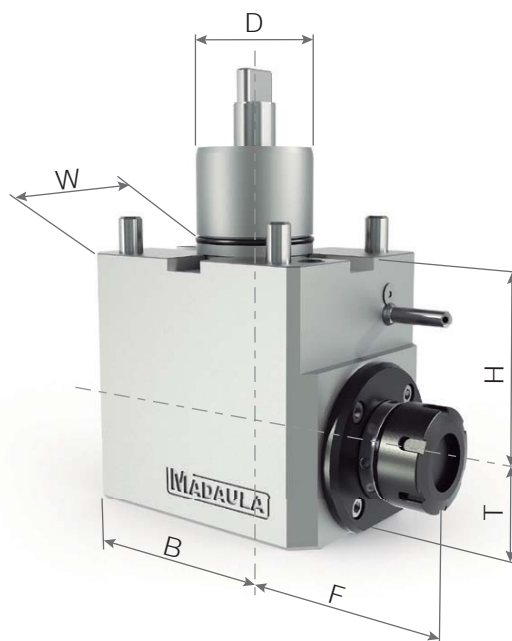

Code	D mm		 RPM. Max.	 1:1	 Nm. Max.		F mm	W mm	W1 mm
MS.000.NL2000	60	ER-32	6.000	1:1	70	-	89	108	130
MS.005.NL2000	60	ER-32	6.000	1:1	70	20bar			



Code	D mm		 RPM. Max.	 1:1	 Nm. Max.		H mm	B mm	F mm	T mm	W mm
MS.010.NL2000	60	ER-32	6.000	1:1	70	-	90	65	107	38	108
MS.016.NL2000	60	ER-32	6.000	1:1	70	20bar					

* The livetools can be equipped with Weldon shaft or shell-mill shaft upon request.